

QUALITY IS OUR STRENGTH

THE 27.2 L REFRIGERANT HAS THE FOLLOWING PROPERTIES:



» **Equipment:** Steel collar



» **Sustainability:** By using the highest quality materials efficiently, we guarantee the longevity of your products as classic reusable packaging.



» **Environmentally friendly:** Fully recyclable packaging with a smaller environmental footprint thanks to our ongoing investment in modern, energy-efficient manufacturing.



» **Valve:** e.g. EN ISO 10297-compliant



» **Technical data:**

Tara weight:	14.7 kg (approx.)
Filling weight:	depending on the medium
Volume:	27.2 l
Test pressure:	48 bar



» **Customer-oriented:** The products are each powder-coated in a single colour as standard and have screen printing and a safety sticker.

We can also customise your product with additional stickers, barcodes, sleeves, two-layer paint or multi-colour finishes according to individual consultation.

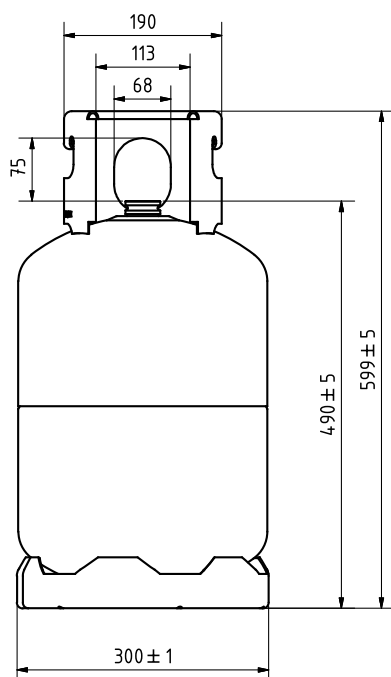

Certification

Gasflaschenwerk Grünhain GmbH is certified in accordance with Directive 2010/35/EU, ADR, RID. Production monitoring and initial testing is carried out in accordance with the above principles by the company's own testing service, which is recognised in accordance with point 1.8.7.6. Certification is carried out by the notified body.

LOGISTICS OUR SERVICE



WE SET STANDARDS - INCLUDING IN LOGISTICS

Deliveries are arranged quickly and flexibly according to your needs. Coordination and cost-neutral shipping for quantities of six or more lorry containers from Grünhain to any location in Germany have been part of our service portfolio for years.



- » Free delivery from six containers
- » 60 bottles per container; maximum 16 containers with 960 units

INFORMATION AND CONTACT

Gasflaschenwerk Grünhain GmbH
Steinmüllerstraße 1
D-08344 Grünhain-Beierfeld

Fon +49 3774 66220
Fax +49 3774 66222

E-Mail info@gasflaschenwerk.de
Internet www.gasflaschenwerk.de